

AUTOMOTIVE TESTER 2201



Copyright © by Autoboss Tech. Inc.



CONTENTS

TRADEMARK INFORMATION.....	2
DISCLAIMER.....	3
COPYRIGHT INFORMATION.....	4
PRECAUTIONS.....	5
INTRODUCTION.....	8
TECHNICAL PARAMETER.....	10
FRONT BOARD OF DIGITAL AUTOMOTIVE TESTER.....	13
OPERATION.....	13
MEASURING DC VOLTAGE.....	14
MEASUREING AC VOLTAGE.....	16
MEASURING DC AMPERAGE.....	16
MEASURING AC AMPERAGE.....	17
MEASURING RESISTACNE.....	17
MEASURING DUTY.....	18
MEASURING TEMPERATURE.....	18
MEASURING TRIODE hFE PARAMETER.....	19
MEASUREING TROIDE.....	19
ON-OFF TESTING.....	20

HOLDING FUNCTION.....	20
DWELL MEASURING.....	20
RPM MEASURING.....	21
MECHANICAL PROTECTION.....	22
SELECTING ANGEL OF THE MULTIMETER.....	23
MAITENANCE.....	23
ACCESSORY.....	24
OPTION.....	24
WARRANTY.....	25

Trademark Information

AUTOBOSS® is a registered trademark of Autoboss Tech. Inc. in China and other countries. All other AUTOBOSS trademarks, service marks, domain names, logos, and company names referred to in this manual are either trademarks, registered trademarks, service marks, domain names, logos, company names of or are otherwise the property of AUTOBOSS or its affiliates. In countries where any of the AUTOBOSS trademarks, service marks, domain names, logos and company names are not registered, AUTOBOSS claims other rights associated with unregistered trademarks, service marks, domain names, logos, and company names. Other products or company names referred to in this manual may be trademarks of their respective owners. You may not use any trademark, service mark, domain name, logo, or company name of AUTOBOSS or any third party without permission from the owner of the applicable trademark, service mark, domain name, logo, or company name. You may contact AUTOBOSS by sending an e-mail to marketing@autoboss.net or writing to **5/F, East, 304 Bldg., Shangbu Industrial Park, Zhenxing Rd., Futian, Shenzhen, China** to request written permission to use materials on this manual for purposes or for other questions relating to this manual.

Disclaimer

All information in this manual is based on the latest product information and is believed accurate at the time of publication. However, specifications and procedures are subject to change without notice.

All information, illustrations, and specifications contained in this manual are based on the latest information available at the time of publication. The right is reserved to make change at any time without obligation to notify any person or organization of such revisions or changes. Furthermore, AUTOBOSS shall not be liable for errors contained herein or for incidental or consequential damages (including lost profits) in connection with the furnishing, performance or use of this material.

To take full advantage of the unit, you should be familiar with the OEM computer systems that are supported.

This manual tells you how to use the unit to perform diagnostic test and to find possible locations of vehicle problems. It does NOT tell you how to correct the problems. Consult your OEM vehicle service manual for repair instruction.

If you experience a problem obtaining service data from a vehicle, it may be due to a vehicle manufacturing design change.

Copyright Information

All rights reserved. Printed in the People's Republic of China. No part of this publication may be reproduced, stored in a retrieval system, or duplicated or transmitted in any manner or by any means, electronic, mechanical, photocopying, recording without prior written permission of AUTOBOSS. The information contained herein is designed only for the use of this unit. AUTOBOSS is not responsible for any use of this information as applied to other units.

Neither AUTOBOSS nor its affiliates shall be liable to the purchaser of this unit or third parties for damages, losses, costs, or expenses incurred by purchaser or third parties as a result of accident, misuse, or abuse of this unit, or unauthorized modifications, repairs, or alterations to this unit, or failure to strictly comply with

AUTOBOSS operating and maintaining instructions. AUTOBOSS shall not be liable for any damages or problems arising from the use of any options or any consumable products other than those designated as Original AUTOBOSS Products or AUTOBOSS Approved Products by AUTOBOSS.

General Notice: Other product names used herein are for identification purposes only and may be trademarks of their respective owners. AUTOBOSS disclaims any and all rights in those marks.

Precautions

1. Safety Precautions



Please read the following precautions carefully before using Digital Automotive Tester 2201.



- As the battery liquid contains sulfuric acid, take care to avoid direct contact of it with your skin. Special attention should be paid to avoid splashing battery liquid into your eyes and keep it away from fire.



- There are various kinds of poisonous venomous compounds such as hydrocarbon, CO, NO in the vehicle exhaust gas. Avoid breathing this gas. Park vehicle in a well-ventilated place while testing.
- The temperature is very high while the engine is running.



- Avoid touching water tank and vent-pipe and any other parts with high temperature.

- Before starting engine, be sure to apply the hand brake, and block the front wheels and shift the gear rod in the neutral position (manual transmission) or the P position (automatic transmission).
- Remember to wear protective gloves while performing the test.
- If you use the battery as power supply, connect the RED jaw to the positive terminal, and the BLACK jaw to the negative terminal.

2. Precautions on Testing with 2201

Read this instruction carefully before testing:

- I The digital automotive tester 2201 is designed meeting the requirements of Class II and GB 4793.1 Pollution and IEC-1010 on Electronic Testing Instrument over voltage (CATII).
- I It is forbidden to make a test with back cover open since there is a danger of electric shock.
- I Check the harness of electronic probes damaged or worn out before testing.
- I Electronic probes must be pulled out first, and then turn the Function/Range Switch before enter or exit the current ranges in order to protect the mechanic devices.
- I The input signal must not exceed the nominal value; otherwise, it will damage the tester.
- I Do not turn Function/Scope Switch while testing.
- I The potential drop will not exceed 1000V between COM and GND; otherwise the operator will be shocked.
- I Be careful when the voltage is higher than DC 60V and AC

42V.

- I Please change a new battery for precision in time testing when the symbol of  displayed.
- I Always use the same specification fuse for the instrument.
- I This tester is an exact electronic system, never break or hit it while operating.
- I Before testing, select the correct testing scope and correct testing leads.
- I Never try to repair the unit.

Introduction

Digital Automotive Tester 2201

----Newly developed digital automotive tester 2201 with super design, easy operation, accurate readings, large LCD display as well as protective mould.













----Unique protective device for wrong operation. The testing port of "mA" or "20A" can only be opened when the current option is chosen, otherwise, a blockage will work at the moment for the protection.

----A PTC thermal element is connected with the input port "V Ω % Δ " so as to guarantee the safety and lifetime as well as the switches for range scope.

----Used to test the voltage & current of DC, the voltage & current of AC, resistor, duty, temperature, parameter of diode and triode, open circuit, dwell and TACH

---Portable tester for automobile testing and maintaining, engineering, lab testing, production testing, field work and home electric appliances repairing etc

Electric symbol

DEWLL		BUZZ	
DC		DOUBLE ISOLATION	
AC		TACH	
LOW BATTERY		HIGH PRESSURE	
ALARM		AD OR DC	
GND		MC	
DIOAD			

CE



CYL

DUTY

Features

1. Low power consumption CMOS double differential A/D converter integrated circuit, automatic zero calibration, automatic pole displaying, data storing, low energy consumption and large measuring range
2. Accuracy of the current: $\pm 0.5\%$
3. Dwell: $0.1^{\circ}\text{C}-120^{\circ}\text{C}$
4. RPM measuring: 10RPM-10000RPM
5. Temperature: $-20^{\circ}\text{C}-1000^{\circ}\text{C}$
6. Automatic power off: the power will be turned off automatically 15 minutes after the power on for the protection
7. Mechanical protection for full range overload
8. Maximum value: 1999(3 1/2)
9. Large LCD display: 70x48mm, the height of the letter up to 28mm
10. Power: 9V battery (NEDA1604, 6F22 or similar)
11. Low voltage alarm: 
12. Dimension: 192x88x42mm
13. Weight: 600g (including battery and mould)
14. Working condition:

Temperature: $0^{\circ}\text{C}-40^{\circ}\text{C}$	Relative Humidity: <85%
Temperature: $-10^{\circ}\text{C}-50^{\circ}\text{C}$	Relative Humidity: <85%
Optimum Temperature: $23^{\circ}\text{C} \pm 5^{\circ}\text{C}$	Relative Humidity: <75%

Technical Parameters

1. DC Voltage

Range	Accuracy	Resolution
2V	$\pm(0.5\%+2)$	1mV
20V		10mV
200V		100mV
1000V	$\pm(0.8\%+3)$	1V

Input Impedance: 10M Ω

Over load protection: DC 1000V or AC 700V (effective value)

2. AC Voltage

Range	Accuracy	Resolution
2V	$\pm(0.8\%+3)$	1mV
20V		10mV
200V		100mV
700V	$\pm(1.2\%+5)$	1V

Input impedance: 10M Ω

Frequency: 40Hz—400Hz

Over voltage protective: DC 1000V or AC 700V (effective value)

Display: average value (sine wave effective value)

3. DC Amperage

Range	Accuracy	Resolution
20mA	$\pm(0.8\%+2)$	10 μ A
200mA	$\pm(1.2\%+2)$	100 μ A
20A	$\pm(2\%+5)$	10mA

Over current protective: 0.2A/250A fuse (no fuse for the range of 20A)

Max. input current: 20A (less than 15s)

Voltage drop: 200mV voltage drop for the full range

4. AC Amperage

Range	Accuracy	Resolution
20mA	$\pm(1\%+3)$	10 μ A
200mA	$\pm(1.8\%+3)$	100 μ A
20A	$\pm(3\%+7)$	10mA

Over load protection: 0.2A/25.A fuse (no fuse fro the ranges of 20A)

Max. input current: 20A (less than 15s)

Voltage drop: 200mV voltage drop for the full range

Frequency: 40Hz—400Hz

Display: average value (sine wave effective value)

5. Resistor

Range	Accuracy	Resolution
200 Ω	$\pm(0.8\%+3)$	0.1 Ω
20K Ω	$\pm(0.8\%+2)$	10 Ω
200K Ω		100 Ω
20M Ω	$\pm(1\%+5)$	10K Ω

Over load protection: 250V, DC or AC effective value

Open circuit voltage: <700mV

6. Duty

Range	Accuracy
0.1%--99.9%	$\pm(1\%+5)$

7. Temperature

Range	Accuracy	Resolution
-20 $^{\circ}$ C—0 $^{\circ}$ C	$\pm(5\%+5)$	1 $^{\circ}$ C



Multimeter 2201

0°C—400°C	$\pm(1\%+3)$	1°C
400°C--1000°C	$\pm(2\%+4)$	1°C

8. Transistor Triode hFE Parameter Testing

Range	Description	Testing Conditions
hFE	Testing the parameter of NPN or PNP triode hFE The range is 0—1000 β	I_b is about 10 μ A, V_{ce} is about 2.8V

9. Diode and On-Off Testing

Range	Resolution	Description	Testing Conditions
	1mV	Displaying the positive voltage drop for Diode	Positive DC amperage is about 1mV Negative DC voltage is about 2.8V
	--	Buzz will work when the resistor of the circuit is lower than 50 Ω	Open circuit voltage is about 2.8V

Over load protection: 250V, DC or AC effective value

10. Dwell for Distributor Contact

Cylinder	Range	Accuracy	Resolution
3CYL	0—120	$\pm(1.2\%+2)$	0.1°
4CYL	0—90°		
5CYL	0—72°		

Multimeter 2201

6CYL	0—60°		
8CYL	0—45°		

11. Rotation Speed (rpm)

CYL	Range	Accuracy	Resolution
3CYL	500—10000 RPM	$\pm(1.2\%+2)$	10RPM
4CYL			
5CYL			
6CYL			
8CYL			

Front Board of Digital Automotive Tester

1. Description



Operation

Press down the Power switch. If the battery voltage is too low, the symbol $\frac{+}{-}$ will be displayed on the left upper screen. You should change a new battery.

Select the required functions and testing ranges.

1. Measuring DC Voltage

- ① Turn the Function/Range knob to the DCV range scope.
- ② Insert the black lead into COM and the red lead into the hole $V \Omega \% \text{ } \overline{\Delta}$. And then connect the lead to the tested load in parallel. The multimeter will display the value of the voltage and the polarity of the red lead at the same time.

Note:

- a. Turn the Function/Range knob to the maximum before measuring the voltage.
- b. The voltage of the tested load is out of the testing scope when the displayed value is "1". You should change another higher range.
- c. The symbol of $\overline{\Delta}$ means the voltage must be lower than 1000V; otherwise, the multimeter will be damaged.
- d. Pay attention to the safety when testing the high voltage.

Application 1. Testing the distributor with DC 2V testing scope

- A. Take down the high tension from the cap of the distributor and short it to ground.
- B. Connect the red lead to the low voltage terminal of the distributor or the negative of the ignition coil; connect the black lead to the ground or the negative of the battery,
- C. Turn on the ignition switch for a while and the multimeter will display the value. The value should be lower than 1V.
- D. Measure the voltage of the contact. If the displayed value is lower than 0.2V, it proves that the contact is good.

Application 2. Leakage testing by DV 2V testing scope

- A. Connect the black lead of the multimeter to the negative of the battery and the red lead to the positive of the battery.
- B. If the multimeter displays a certain value, it proves that the battery is leaking. The best way is to clean the battery immediately.

Application 3. Testing the loading capacity with 20V testing scope

- A. Connect the black lead to the negative of the battery and the red lead to the positive of the battery respectively.
- B. Turn on the headlights, the flash light switch, the ignition switch and the radio.
- C. The operating time is no longer than 2 minutes.
- D. Checking the displayed values. If the value is lower than 11.7V, you should change another battery or charge it.

Application 4. Testing the battery capacity by 20V testing scope

- A. Take down the high tension from the cap of the distributor and short it to ground.
- B. Connect the black lead of the multimeter to the negative of the battery and the red lead to the positive of the battery.
- C. Start the engine for 15 seconds and check the displayed values. If the value is higher than 9.1V, it proves that the battery is ok. Otherwise, you have to check the engine or charge the battery or replace it.

Application 5. Testing the battery cable

- A. Test the voltage of the battery cable as well as the working conditions when starting the engine

Application 6. Checking the charging system

Application 7. Checking the voltage regulator

2. Measuring AC Voltage

- a. Turn the Function/Range knob to the ACV testing scope
- b. Insert the black lead into COM hole and the red lead into the hole with the symbol of $V \Omega \% \text{⚡}$. Meanwhile, parallel the lead to the tested load.

Note:

- a. Turn the Function/Range knob to the maximum before measuring the voltage.
- b. The voltage of the tested load is out of the testing scope when the displayed value is “1”. You should hange another higher range.
- c. The symbol of \triangle means the voltage must be lower than 700V; otherwise, the multimeter will be damaged.
- d. Pay attention to the safety when testing the high voltage.

3. Measuring DC Amperage

- a. Take out the testing lead and turn the Function/Range knob to the DCA testing scope
- b. Insert the black lead into COM hole and the red lead into the hole with mA or 20A. Connect the testing lead in series in the circuit. The multimeter will display the readings as well as the polarity of the red lead.

Note:

- a. Turn the Function/Range knob to the maximum before measuring the voltage.

- b. The voltage of the tested load is out of the testing scope when the displayed value is “1”. You should change another higher range.
- c. The overload will damage the in-built fuses when testing by mA scale. The specification of the fuse is 0.2A/250V
- d. Never exceed 15 seconds when testing the load by maximum current 20A. There is no fuse at the scale of 20A.

4. Measuring AC Amperage

- a. Take out the testing lead and turn the Function/Range knob to ACA testing scope.
- b. Insert the black lead into the COM hole and the red lead into the hole with mA or 20A. Connect the testing lead in series in the circuit.

Note:

- a. Turn the Function/Range knob to the maximum before measuring the voltage.
- b. The voltage of the tested load is out of the testing scope when the displayed value is “1”. You should change another higher range.
- c. The symbol of  means the voltage must be lower than 1000V; otherwise, the multimeter will be damaged.
- d. Pay attention to the safety when testing the high voltage.

5. Measuring Resistance

- a. Turn the Function/Range knob to Ω testing scope.
- b. Insert the black lead into COM hole and the red lead into the hole with $V \Omega \%$ . Connect the testing lead in parallel in the circuit.

Note:

- a. When the circuit is open, the multimeter is in the testing state, the display the maximum
- b. When the tested resistor is higher than $1\text{M } \Omega$, the multimeter will display the stable values after few seconds. It is normal for testing high resistant.
- c. Turn off the power supply for the tested circuit and let the capacitor discharge when testing the resistors, which is already connected in the circuit.

Application 1. Testing the impedance by the scale of 20Ω and $200\text{k } \Omega$

Application 2. Checking the working conditions of the capacitor by $20\text{M } \Omega$

6. Measuring Duty

- a. Turn the Function/Range knob to DUTY scale.
- b. Insert the black lead into COM hole and the red lead into the hole with $V \Omega \% \frac{dA}{dA}$.

7. Measuring Temperature

Turn the Function/Range knob to $^{\circ}\text{C}$ scale. Insert the testing plug of the thermal coupler into the multimeter socket when testing the temperature. Pay attention to the polarity of the positive and negative. Put the testing end of the thermal coupler to the tested parts. The multimeter will display the temperature values. The unit is degree ($^{\circ}\text{C}$).

Note:

- a. The displayed values are the temperature of the tested parts when the thermal coupler inserted into the socket.

The displayed values are the environmental temperature when the circuit is open.

- b. The temperature limit for the thermal coupler (TP-01 Type K) provided by the factory is 250°C. (The limit value can reach 300°C in a short period.)

8. Measuring Triode hFE Parameter

- a. Turn the Function/Range knob to the hFE scale.
- b. Check the type of the Triode. Insert the Pin E, B, C into the right holes.
- c. The displayed values are approximate. The current for the basic polarity is 10 μ A and the voltage is 2.8V

9. Measuring Triode

- a. Turn the Function/Range knob to the  scale.
- b. Insert the black lead into COM hole and the red lead into the hole with V Ω %A. Pay attention to the polarity of the read lead. Connect the testing lead in parallel with the tested diode. The multimeter will display the positive voltage drop for the diode with the unit is V. The multimeter will display over range when the diode connected in the opposite direction.

Note:

- a. When the circuit is open, the multimeter will display over range.
- b. Normally, the current for the tested components is 1mA.
- c. It can be used to check the conditions of the rectifier diode.

10. On-Off Testing

- a. Turn the Function/Range knob to the scale of 
- b. Insert the black lead into COM hole and the red lead into the hole with $V \Omega \% \text{A}$. Connect the testing lead in series in the circuit.
- c. The buzz will make the sound of Di-Di when the resistance is lower than 50Ω .

Note: Check the circuit when the power off otherwise an error will come up.

11. Holding Function

The multimeter will display the letter H when the Hold button pressed. It is easy for you to read the measured values with this function. The letter H will disappear when the button pressed again.

12. Dwell Measuring

- a. Insert the black lead into COM hole and the red lead into the hole with $V \Omega \% \text{A}$.
- b. Turn the switch to the scale of DWELL according to the cylinder numbers.
- c. Connect the black lead to ground or the negative of the battery and the red lead to the low voltage terminal of the distributor. See the following pictures
- d. Start the engine and read the dwell by the multimeter.

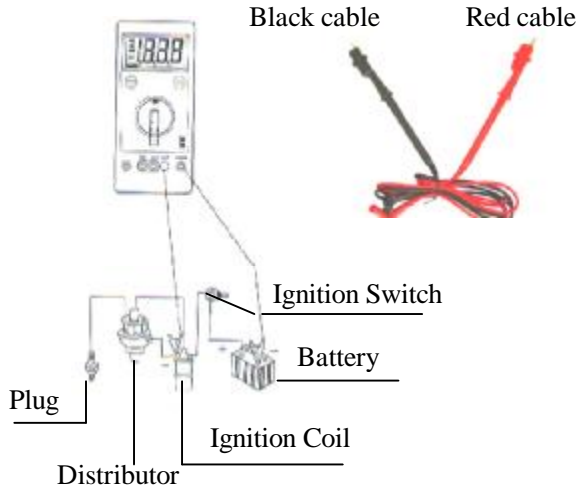

Picture for RPM testing

14. Mechanical Protection

The multimeter has a movable plate. It can protect error operation. The plate can move between the function and range knob. The mechanical protection is listed as following:

(The symbol ● means the hole is blocked. The black lead can insert into the hole)

Position of Switch	The hole blocked		
	 V Ω % _{ΩA}	mA	20A
Voltage for DC and AC		●	●
Current over 20A for DC and AC	●		●

Multimeter 2201

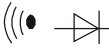
Current within 20A for DC and AC	•	•	
Resistance Ω		•	•
		•	•
Triode hFE parameter	•		•
Duty		•	•
Temperature $^{\circ}\text{C}$	•		•
Dwell, rpm		•	•

The Function/Range knob cannot move if you forget to pull out the testing leads.

Pull out the testing leads before turning the Function/Range knob otherwise the mechanical protection will be damaged.

15. Selecting the angle of the Multimeter

A protection mould provided for the protection. You can adjust the holder for the readings at different angles.

Maintenance

Digital automotive tester 2201 is an accurate tool. It should be kept carefully.

1. Do not test the DC voltage higher than 1000V or AC voltage higher than 700V with digital automotive tester 2201.
2. Pull out the testing leads before turn the Function/Range knob. Otherwise, the mechanical protection will be damaged.
3. Do not use the digital automotive tester 2201 if the back cover is not in the right position.

4. Pull out the testing leads or turn off the power before exchange a new battery. Turn out the screw and push the battery cover. Take down the battery cover and change a new battery with the same specification.
5. Pull out the testing leads or turn off the power before exchange the fuse. Turn out the screw and open the back cover of the multimeter. Change a new fuse with the same specification. Close the back cover and screw it.
6. The specification of the fuse is 0.2A/250V
7. Take out the battery and put it in dry and ventilation places if you DO NOT use the multimeter for a long time.
8. DO NOT try to change the interior circuit

Accessory

1. User Manual
2. Quality Certificate
3. Protection Mould
4. Testing Leads
5. Type K Thermal Coupler

Option

SMD clammer: can be used to test the parameter of the resistance, capacitance, inductance, and transistor.

Warranty

THIS WARRANTY IS EXPRESSLY LIMITED TO ORIGINAL PERSONS WHO PURCHASE AUTOBOSS PRODUCTS FOR PURPOSES OF RESALE.

AUTOBOSS is warranted against defects in materials and workmanship. This warranty does not cover any Autoboss that has been abused, altered, used for a purpose other than that for which it was intended, or used in a manner inconsistent with instructions regarding use. The sole and exclusive remedy for any Autoboss found to be defective is repair or replacement, at the option of AUTOBOSS in accordance with procedures established by AUTOBOSS.

In no event shall AUTOBOSS be liable for any damages, direct or indirect, special, incidental or consequential or compensatory, including, without limitation, lost profits, for any representations, breaches or defaults arising out of the use of this manual.

Customer agrees to indemnify AUTOBOSS and hold it harmless against all claims and damages, including without limitation, reasonable attorney's fees arising out of the use of this manual, unless such claims or damages result from the infringement of any copyright or other proprietary right of any third party. No one is authorized to make any statement or representation altering the terms of this warranty. No agent, employee, or representative of AUTOBOSS has any authority to bind AUTOBOSS to any affirmation, representation, or warranty concerning AUTOBOSS automotive meters, except as stated herein.

Disclaimer

THE ABOVE WARRANTY IS IN LIEU OF ANY OTHER WARRANTY, EXPRESS OR IMPLIED, INCLUDING ANY WARRANTY OF MERCHANTABILITY OR FITNESS FOR A PARTICULAR PURPOSE.

Specifications contained in this book are based on the manufacturers' information and were believed accurate at the time of publication. All information, illustrations, and specifications contained in this technical manual are based on the latest information available at the time of publication.

The right is reserved to make change at any time without obligation to notify any person or organization of such revisions or changes. Furthermore, AUTOBOSS shall not be liable for errors contained herein or for incidental or consequential damages (including lost profits) in connection with the furnishing, performance or use of this material. To take full advantage of the unit, you should be familiar with the OEM computer systems that are supported.

This manual tells you how to use the unit to perform diagnostic test and find possible locations of vehicle problems. It does NOT tell you how to correct the problems. Consult your OEM vehicle service manual for repair instruction. If you experience a problem obtaining service data from a vehicle, it may be due to a vehicle manufacturing design change. Vehicle manufacturers now introduce new product lines year-round. To obtain test data on a mid-year vehicle, you may need to program the tester to the next model year available in the software cartridge, not the actual VIN year of the vehicle being tested.

Order Information

Replaceable and optional parts can be ordered directly from your AUTOBOSS authorized tool supplier. Your order should include the following information:

1. Quantity
2. Part number
3. Item description

Customer Service

For any quality problems, please contact the local distributor or direct contact Autoboss Tech. Inc.

Autoboss Tech. Inc.

5/F, East, 304 Bldg., Shangbu Industrial Park, Zhenxing Rd., Futian, Shenzhen, China

Tel: 0086-755-83285146

Fax: 0086-755-82170248

E-mail: marketing@autoboss.net

Website: www.autoboss.net